

IFB LAUNDROMATIQUE

Your partner in growing your business

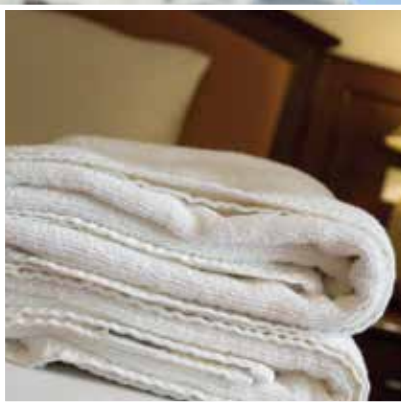

THE LAUNDROMAT
A fresh look at laundry



GROW
WITH US



Become an entrepreneur, invest in a business model that is both recession and pandemic proof; made to weather even the most trying of times.

People will always need clean clothes!

No matter what's going on in the world; health crisis, economic recession or a normal day—freshly washed clothes are an essential. Cleanliness is crucial and sanitation starts with your laundry.

Now more than ever, people need easy access to high-quality laundry equipment. A modern laundromat is almost 100% recession and pandemic-proof.

start a laundry business...

WHY OPEN A LAUNDROMAT

SMART EARN

01 GREAT ROI!

How many businesses can say that? Not many. If you have free space, this is the best choice for you. The neighbourhood dhobi has evolved to a hygienic laundromat that can assure you safety and cleanliness

02 LOW INVENTORY

Unlike a restaurant or grocery store, laundromats have very little physical inventory. Minimal ordering, rotating or discarding products, which makes it easier for management. No need to store expensive inventory in advance.



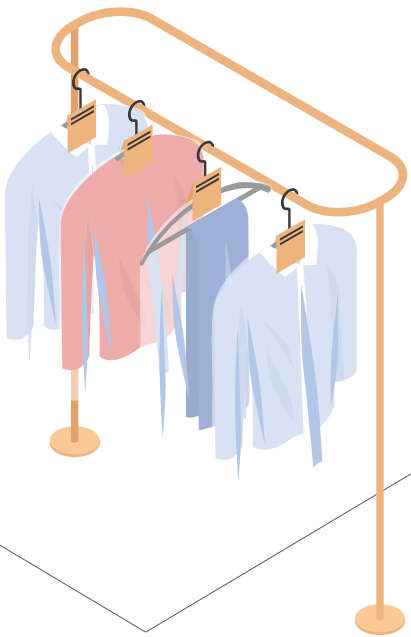

03 NOT SEASONAL

People always need to do laundry—clean clothes are an essential!

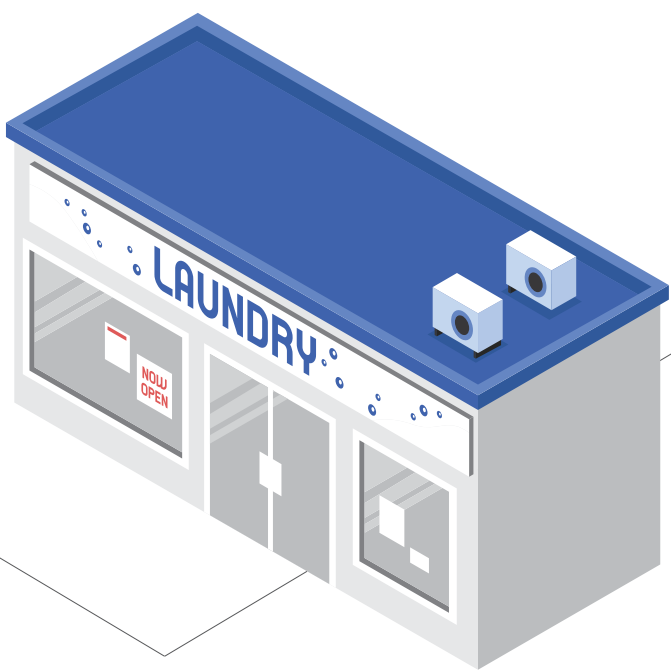

04 BUSINESS vs FRANCHISEE

Setting up your own small business eliminates pricey franchise fees. Build your business as you see it.



05 MINIMAL EMPLOYEE MANAGEMENT

One or two employees are enough, no large team means less management hassle, lighter payroll and smoother scheduling. More profit for the investor.



06 RECESSION RESISTANT

Clean clothes to wear are never going out of fashion. Unlike tourism or real estate, the laundry industry isn't impacted by economic recession, as much.

07 SCALE UP

A simple set up which has potential for multiple locations and expansion. The flexibility, versatility and necessity of the laundry industry offer tremendous opportunities for growth. Technology makes enabling this even easier.



08 FLEXIBILITY

Play around with your time, you do not need to be present all the time. In fact, if you already own a business, this is a good opportunity for additional income. Remote monitoring gives you even more flexibility.



09 COMPLETE SET-UP

We provide you with a 360° solution, including the machines, installation, maintenance and service. A range of detergents and the support of an app to run your business are also available.



10 ADDITIONAL SERVICES

You can offer additional services (like dry cleaning or full wash-dry-fold service). Trending laundromats across the world are cafes, yoga centres, WiFi zones and so much more.





**Mask
Required
Area**

ADAPTABILITY OF THE BUSINESS



WHERE TO SET UP A LAUNDROMAT?

Apartment Complexes
Hostel Dorms
Small Hospitals
Retirement Communities
In Your Neighbourhood
Guest Houses
Day Cares
Clubhouses
Lounges
Resorts
Farm Houses
Duplexes
Condos

WHO CAN SET UP A LAUNDROMAT?

Small Business Owners
Start Ups
As a Second/Side Business
Retired People

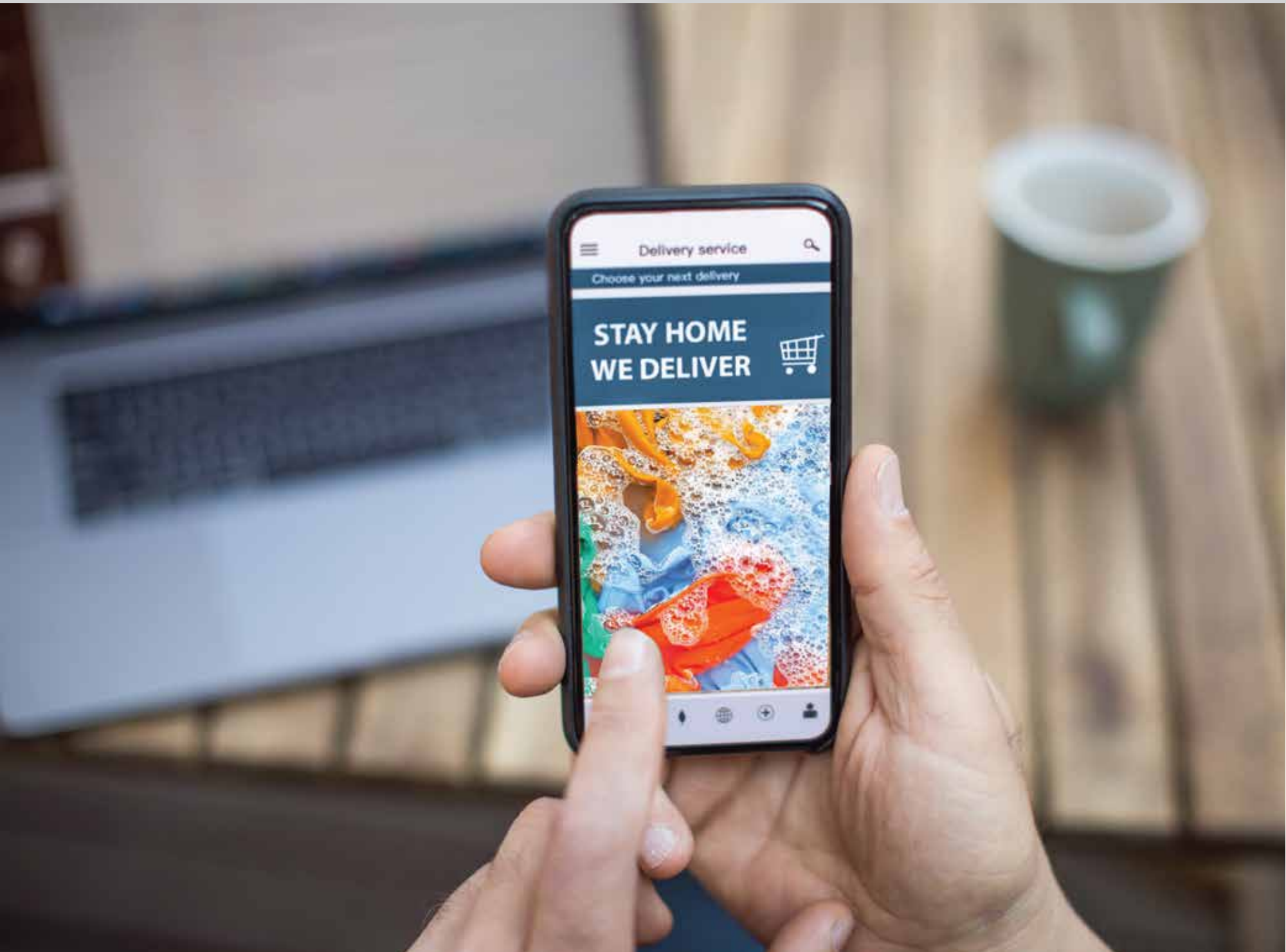

TOUCHLESS, CASHLESS OPTIONS

Adapt and upgrade with cashless and no-contact payment methods, such as mobile and card payment options. This helps keep customers and employees safer. Digital records make it easier for customers to monitor spending quickly and easily when budgets are tighter.

PICK UP AND DELIVERY OPTIONS

Laundromats can be adapted to a contactless business. Train staff and adapt to a complete laundry drop-off and pick-up or delivery operation. Offer this as a 'luxury' service, at a premium to generate more revenue. This will help your business navigate through difficult times.

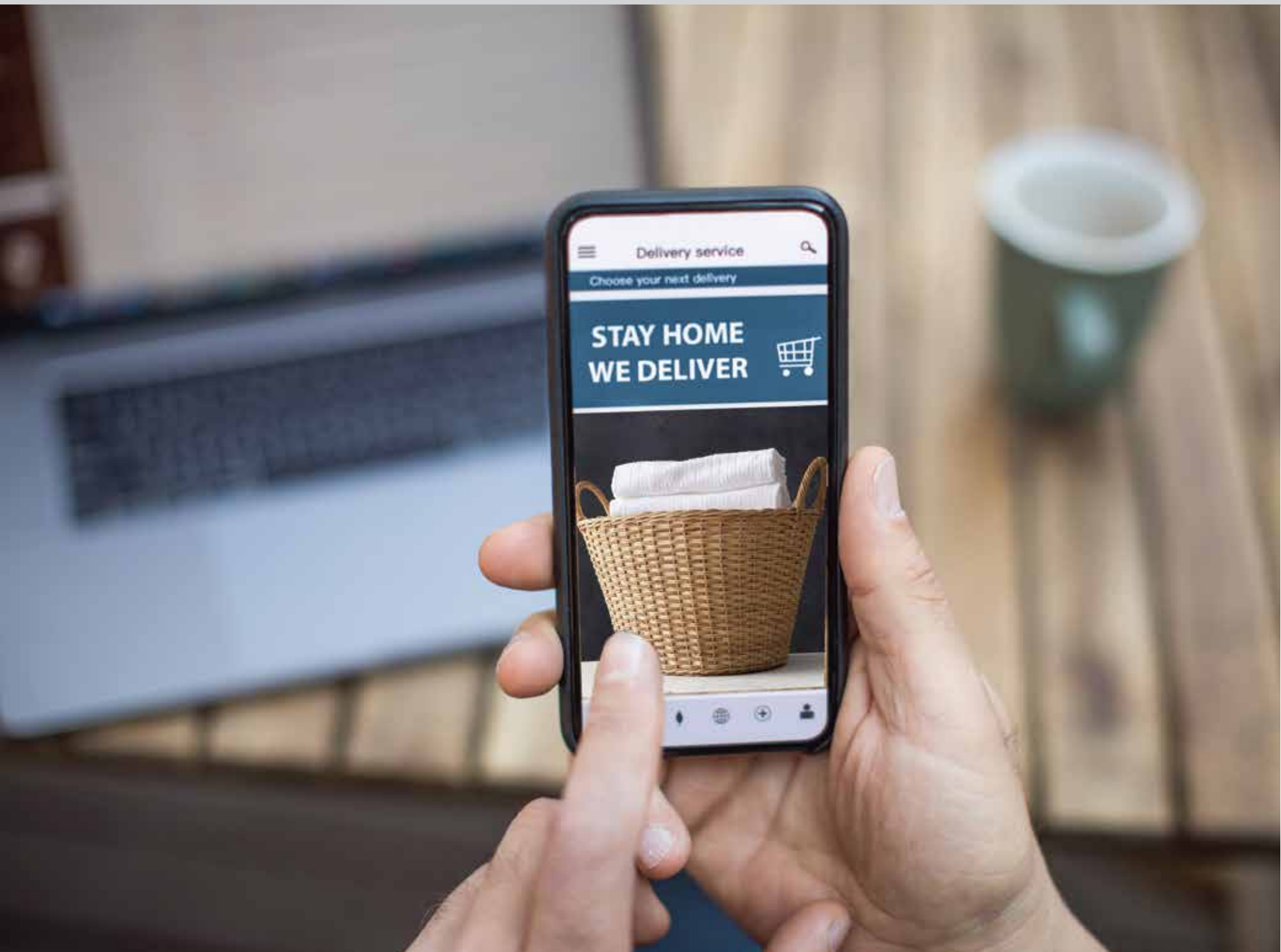

ADJUST OPTIONS AND PRICING

Today's laundry equipment has more features and controls than ever—soft PLC controls, 20 wash programs and customisable options like extra rinse, cold rinse, water level, wash temperature etc. Easily monitor your equipment and troubleshoot problems, all remotely. Additionally rinse cycles, hot wash and other upsells give you more control over cleanliness and costs. Introduce features to help boost profitability like time of day pricing—during rush hours offer premium pricing, during slower hours keep normal pricing, you can also charge extra for any value added wash—like extra rinse, sanitise etc.

TRUE VOLUME LOAD

Washing 11 kg. Drying 11 kg. All in a single laundry cycle! True volume of the wash. Cater to 80–100 kg load/day. The washer extractor and tumble dryer both have a capacity of 11 kg.

SOLID STEEL

The machines have a built to last stainless steel body. They are robust, durable and steadier for smooth operation. Run them continuously for 8–10 hours/day.

CUSTOMISE

Fully programmable Touch Screen PLC. Wash your laundry your way with 20 customisable programs—hot rinse, cold rinse, cold wash, detergent input etc.

CUSTOMISED
PROGRAMS



UNIQUE TURNKEY SOLUTIONS



DESIGN



INSTALL



TRAIN



WARRANTY

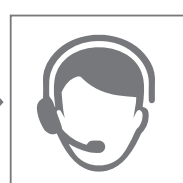

SUPPORT

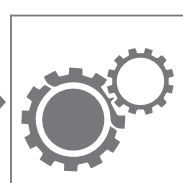

SPARES

SMART DUO DRYER 11 KG



TWO SEPARATE MACHINES ARE AN EASY FIT

Soft mounted, compact sized machines for better space utilisation.

SWINGS BOTH WAYS

The tumble dryer drum has bi-directional rotation. Clothes don't get tangled up and are easier to iron.

APP—REMOTE CONTROL

India's first laundry solution can be completely accessed through an app— coinless payment, digital operations, laundry status etc.

SERVICE AND SAVINGS

Lower electricity bills—uses less energy to dry because the washer extractor removes 70% of the water. After sales service support from IFB ensures zero downtime.



IFB LAUNDROMATIQUE

Your partner in growing your business

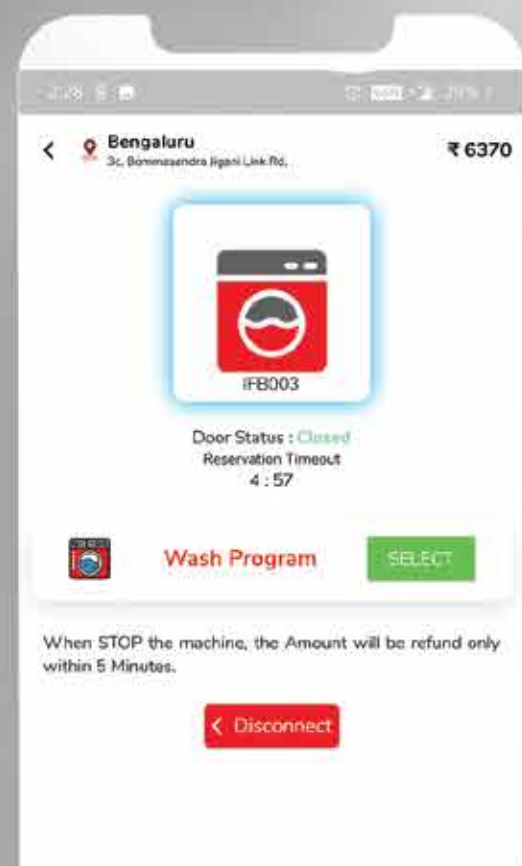
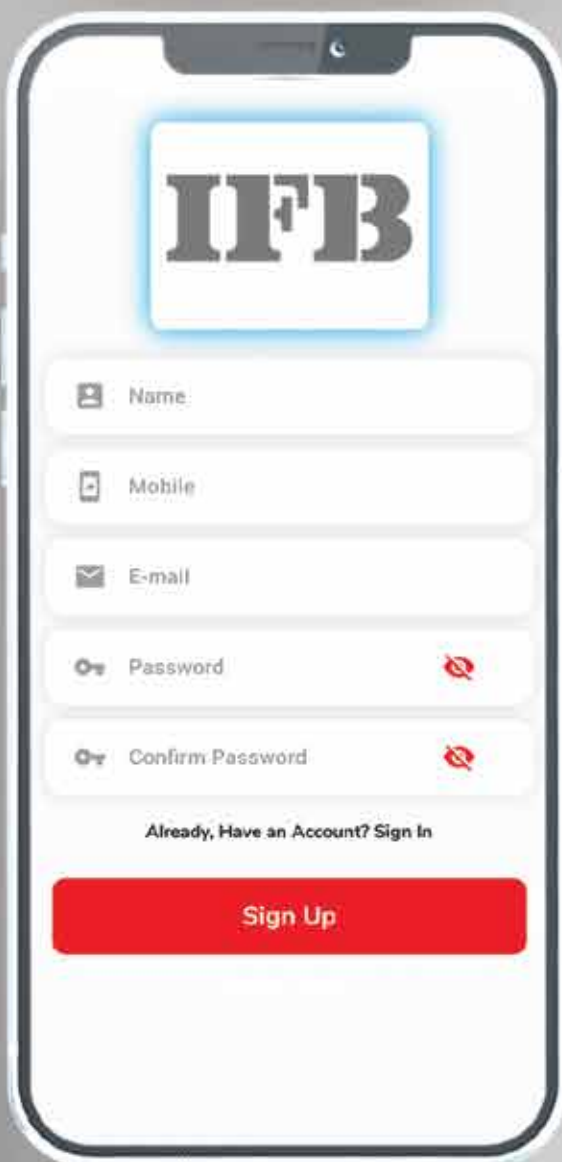
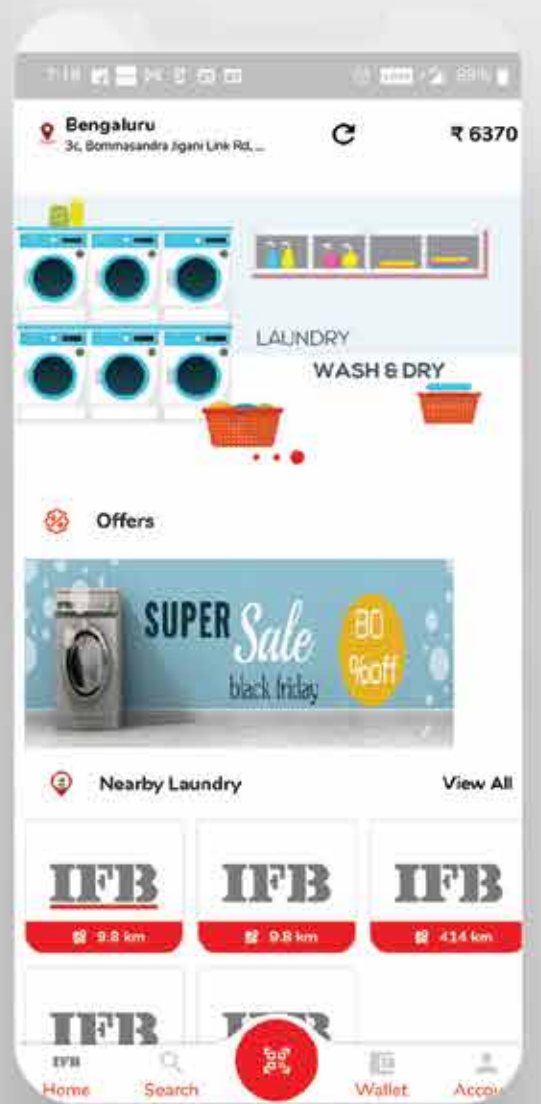
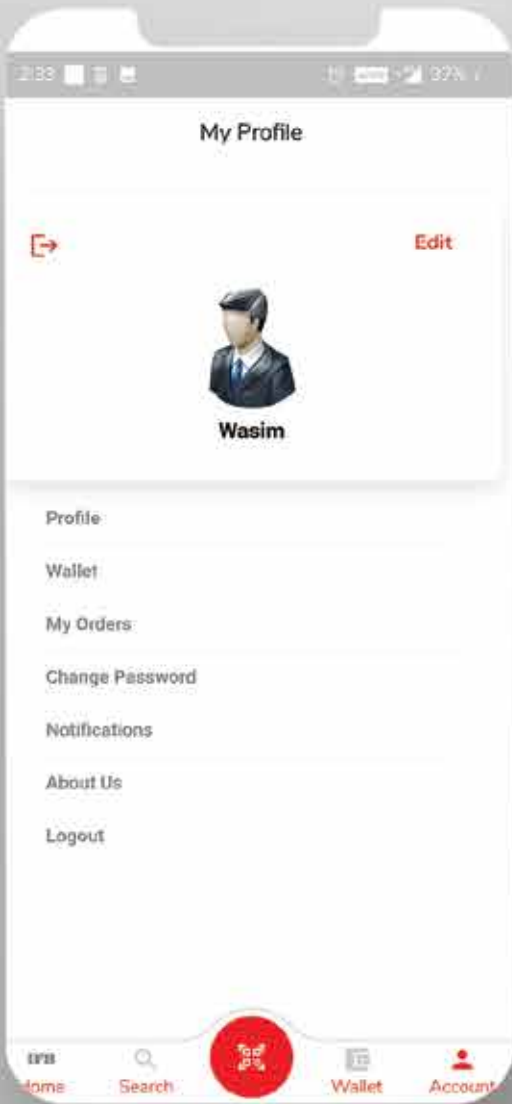



**WEB & MOBILE APP—FOR
USERS, VENDORS & ADMIN**



**A SMART, WiFi
SELF SERVICE
LAUNDROMAT APP**

The days of coin-operated machines are gone forever. The customer demands a seamless, touch-free operation, as far as possible.

Using an app-based location service the user can

- find the nearest laundromat
- view machines and services
- pre-book a slot on the machine
- view and make payments

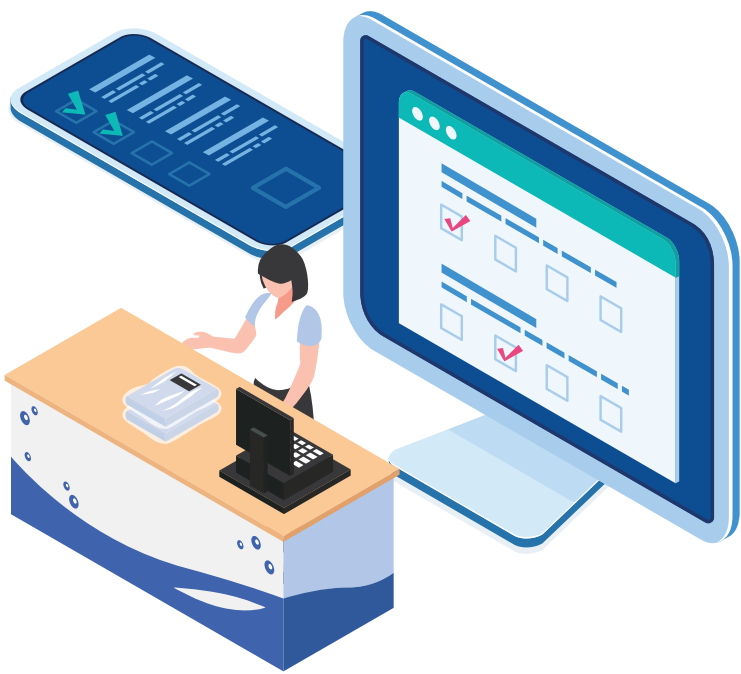

MOBILE APP AND WEB APPLICATION FOR THE VENDOR

Connect and run all your laundromats through this super app!

- manage branches from here
- each machine gets a unique ID code, manage the machine, customise programs and pricing
- get alerts and machine fault notifications
- view customers, orders and payments
- view the earnings report and monthwise profit report per machine on the app



WEB APPLICATION FOR THE ADMIN MODULE

The admin login enables you to seamlessly scale up the operation and control it at one touchpoint

- manage vendors, branches, assigned machines, money
- add machines and assign them to vendors
- manage services and view customer orders
- view past orders, current order and payment status
- view machinewise or vendor-wise reports

UNCOMPROMISE ON PERFORMANCE

Washes and dries an 11 kg load in a single cycle.



TRUE 11 KG VOLUME

Hygienically washes an 11 Kg load at 60°C and dries it at 70°C in just 80 minutes.



CUSTOMISED PROGRAMS

Wash as per your needs using a fully programmable touch screen PLC with 20 customisable programs like temperature, extra rinse, soak, detergent etc.



HIGH WATER EXTRACTION

Removes more than 70% water for quicker drying and maximum energy savings.



BI-DIRECTIONAL ROTATION

The tumble dryer drum rotates in two directions ensuring less wrinkles and tangle-free clothes.



AUTO COOL DOWN

Activates at the end of the drying program to reduce wrinkles and untangle clothes.



AUTO IMBALANCE VIBRATION CONTROL

Smart sensing mechanism to detect and correct any imbalance during spin.

UNCOMPROMISE ON AESTHETICS & EASE OF USE

Remote controlled machines with stainless steel bodies.



EASY-TO-USE

Convenient program selection control panel and a large display.



APP-BASED CONTROL

An optional Web and Mobile based App is available. It works at 3 levels—users can operate the machine and make payments; vendors can control and check machines; administrators can use the web app to monitor vendors for reports and tracking payments.

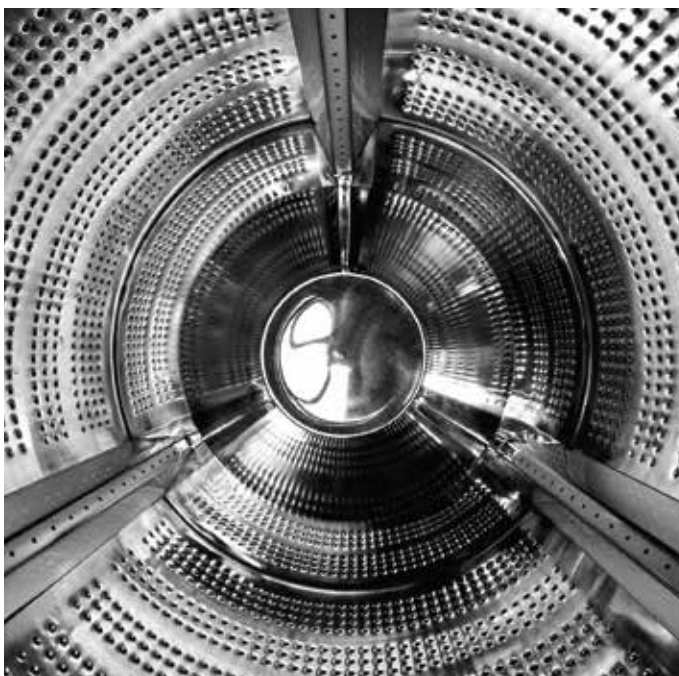

STAINLESS STEEL DRUM

Ensures the surface remains smooth and gentle on clothes even after continuous use.

ROBUST DESIGN

The stainless steel body and heavy weight make the machines stable and durable.



**UNCOMPROMISE
ON PEACE OF MIND**

Dedicated 24x7 service in both warranty and post warranty periods.

Load Washed/Day

[11 kg (Capacity) x 7 (Hours) x 85%]

65 kg

Price/kg

₹120

Earnings/Month

₹40,846.40

Breakeven Load/Day

16.48 kg

Payback Period

11.4 Months



HIGHER SAVINGS

Cut down on utility bills due to lower operating costs

QUICKER ROI

Shorter turnaround time mean more output and faster Return On Investment. You can earn your investment back in just one year!

Note These calculations are based on standard ROI methods on investments and average laundry price. The payback period may differ for each customer.



WARRANTY

IFB machines are built to last with a one-year warranty and 7–10 years spare part support. Extend the protection of your machine with a CAMC and AMC for the post warranty period.



SERVICE NETWORK

Nationwide presence of trained service engineers.



SPARES SUPPORT

A spare part inventory is maintained at all key towns to ensure minimal downtime.



SMART \$AVE

STERILISED LAUNDRY
80 MINUTES

LAUNDRY RECEIVED



WASHING
45 min



DRYING
30 min



IRONING
5 min

READY TO DELIVER!

If you are considering opening a laundromat, we are here to help you every step of the way. Contact our team of laundry experts to discuss your needs today!

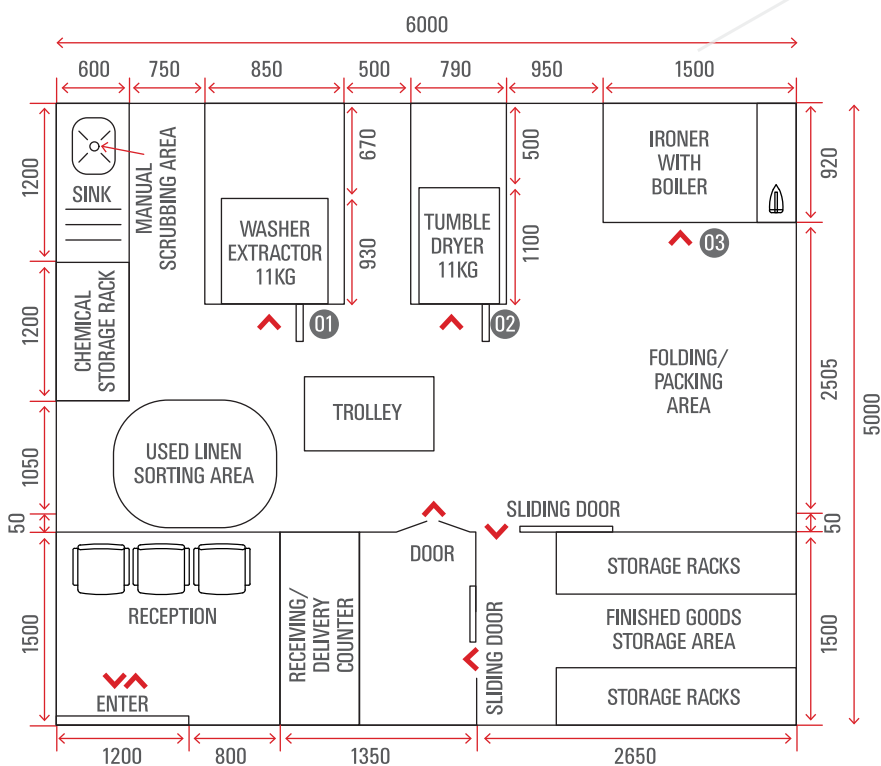
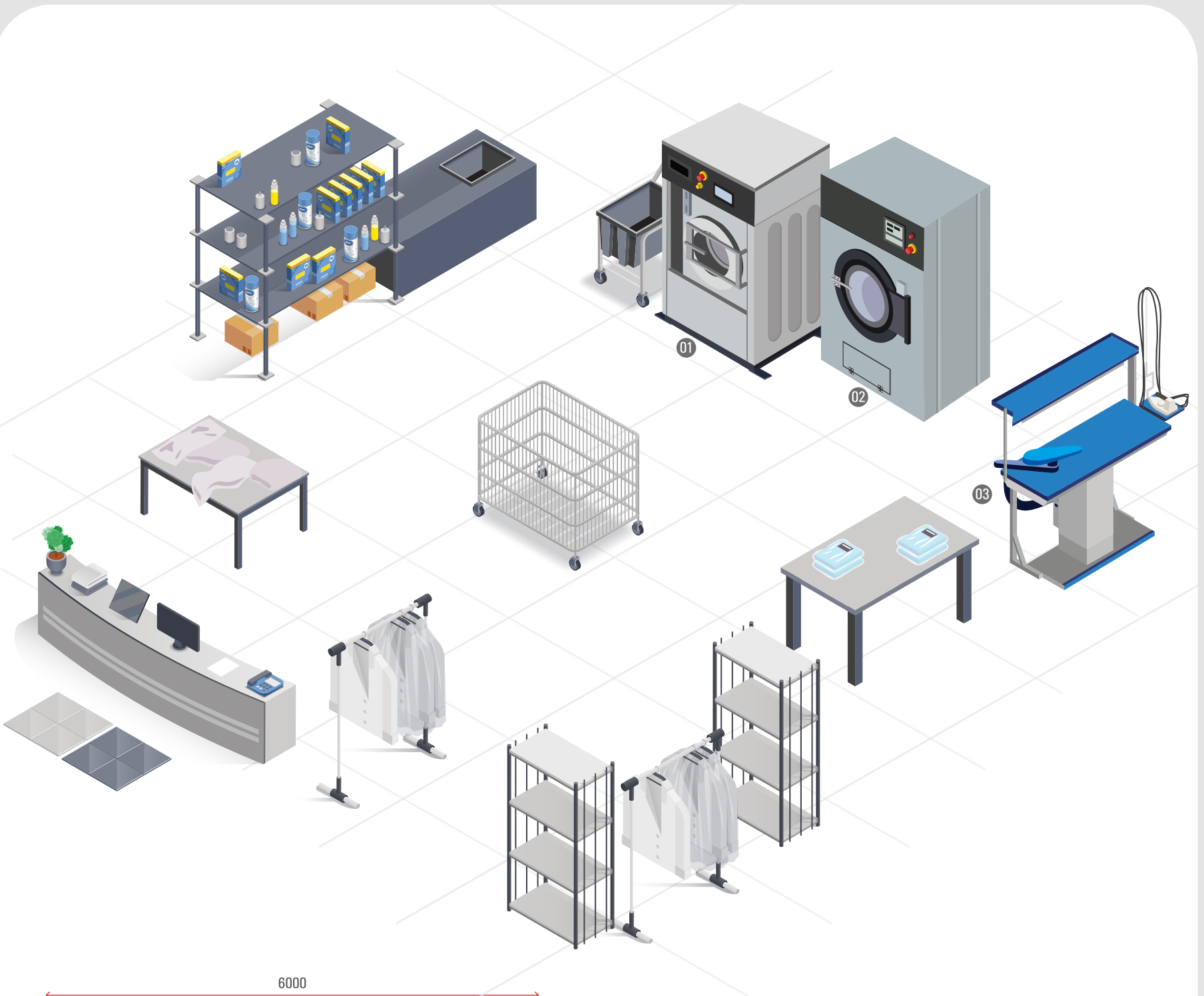

SMALL CAPACITY LAUNDROMATIQUE

- 11 Kg Washer Extractor
- 11 Kg Tumble Dryer
- VIT with Boiler

**PLAN YOUR SPACE
SMALL 320 SQ FT**

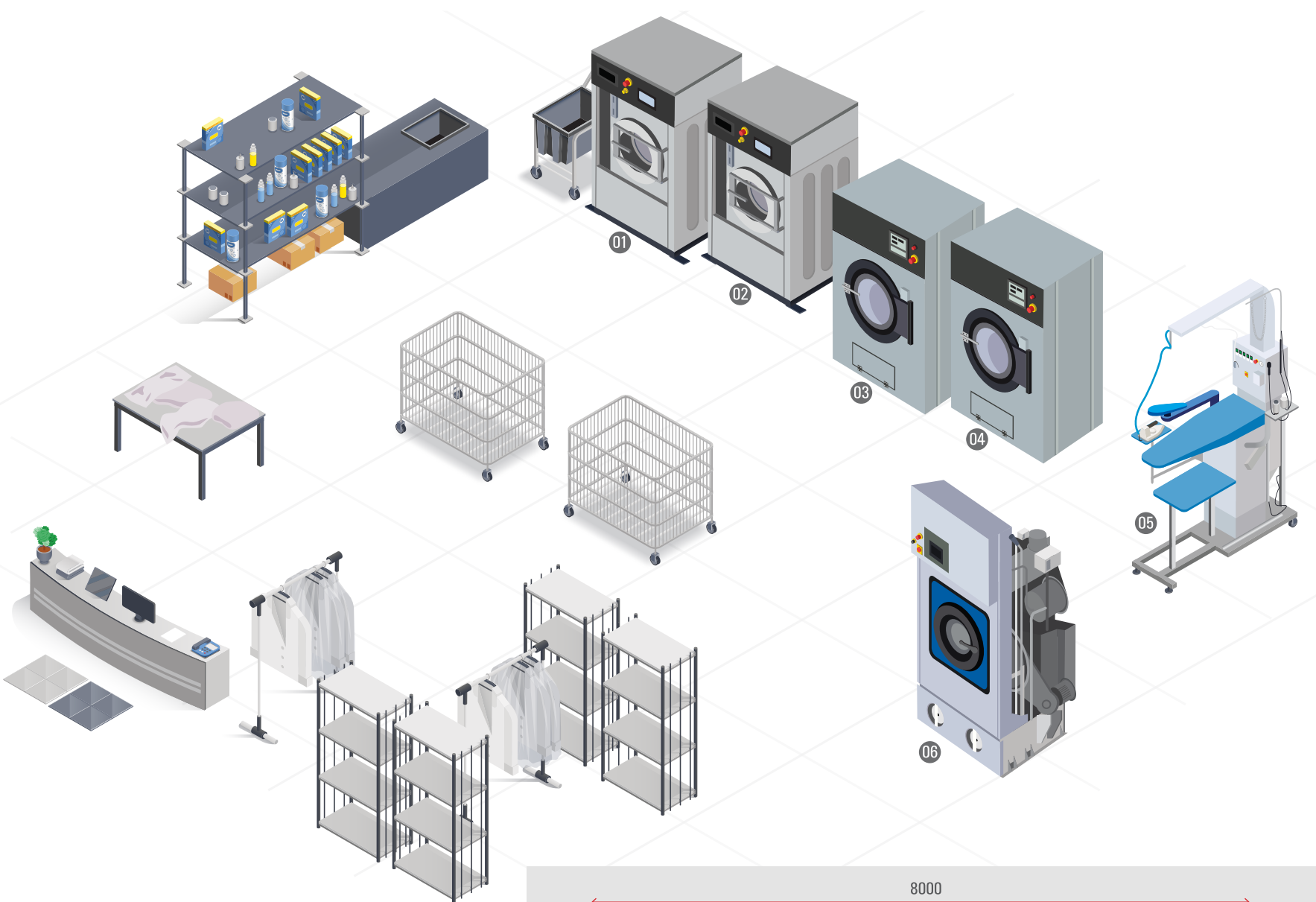

LARGE CAPACITY LAUNDROMATIQUE

- 2 Washer Extractor 11 Kg
- 2 Tumble Dryer 11 Kg
- Dry Cleaning Machine
- Dress-O-Matic

PLAN YOUR SPACE
LARGE 560 SQ FT

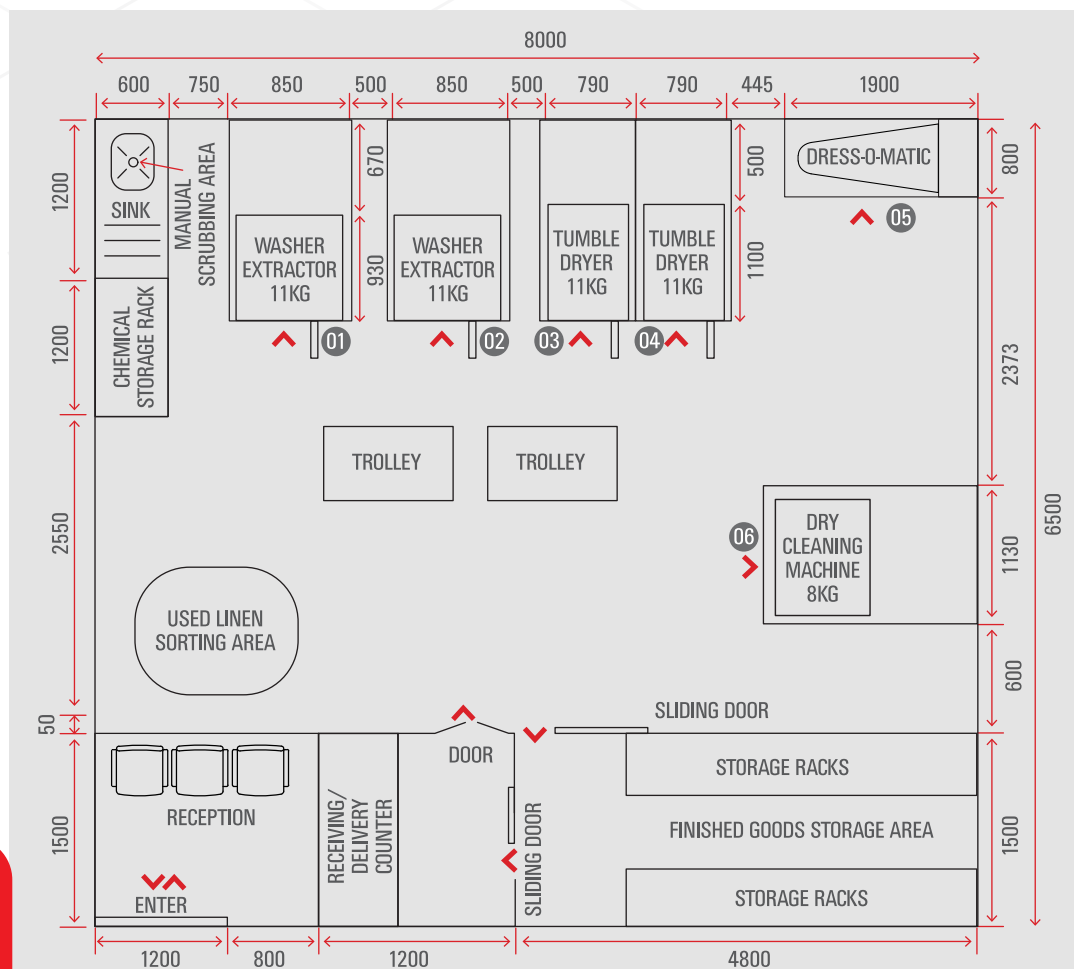

IFB LAUNDROMATIQUE

Your partner in growing your business



AUTO DOOR INTERLOCK



CHEMICAL COMPARTMENT



INVERTER DRIVE

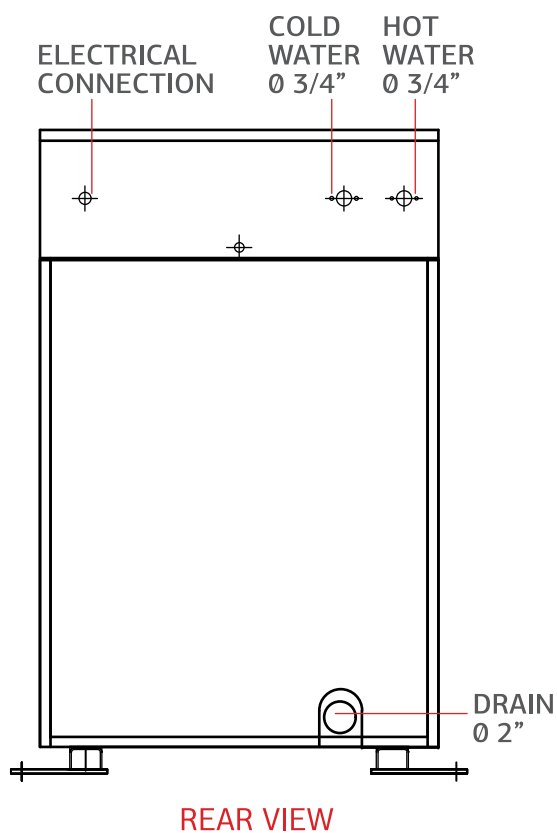
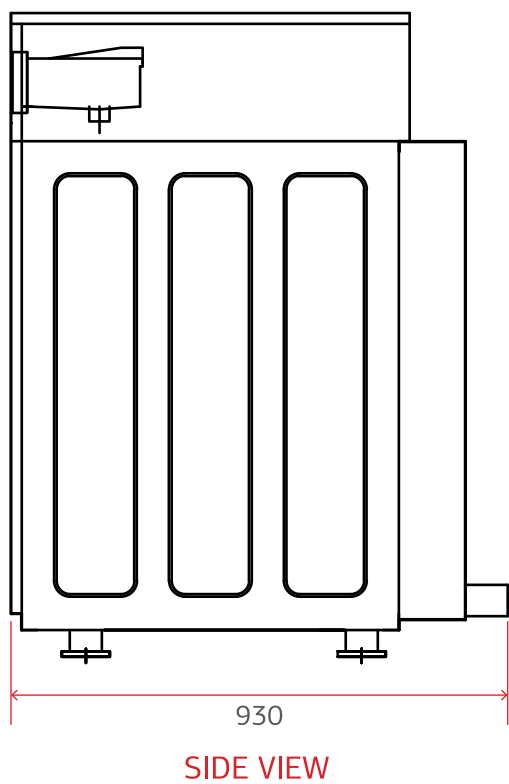
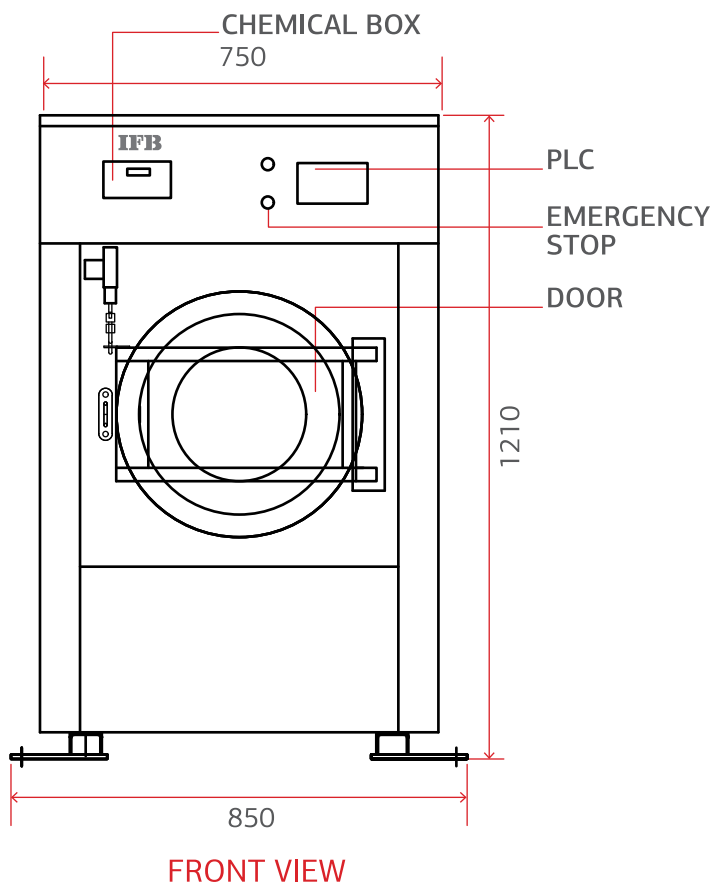

WASHER EXTRACTOR (11KG) IWE 108

Capacity (kg)	11
Heating Type	Electrical
Motor Size (HP/kW)	1.5/1.1
Electrical Heating (kW)	6
Extraction Speed	
Max G-force	350
Max RPM	1,040
Washing Speed (Adjustable) RPM	36–40
Basket Capacity	
Volume (Ltr)	110
Diameter (mm)	580
Depth (mm)	416
Dimensions	
Width (in/mm)	34/850
Depth (in/mm)	37/930
Height (in/mm)	48/1,210
Door Diameter (in/mm)	16/400
Crated Dimensions	
Width (in/mm)	36/910
Depth (in/mm)	42/1,065
Height (in/mm)	53/1,340
Approximate Weight	
Uncarted (lb/kg)	572/260
Carted (lb/kg)	625/284
Electrical Requirements	
Electrical Rating	415 V, 50 Hz, 3 Phase + N + E
Breaker/Fuse (Amps)	20
Operating Control	
PLC Model	LEVI2043E-N/ST 2002
Speed (RPM) Control	VFD Controlled
Door Locking	Electrically Interlocked
Optional Features	
Remote Control through Mobile/Wi-Fi App	
Electrical Energy and Water Consumption Data/Display	
Water Connections	
Water Inlet (in)	Dia ¾" x 2 (Hot & Cold)
Operating Pressure (PSI/Bar)	29–58/2–4
Drain Size (in)	Dia 2", Electrically Operated Valve
Chemical Compartment	A, B, C
Warranty	1 Year



**POWDER COATED OUTER BODY
CONSTRUCTION**

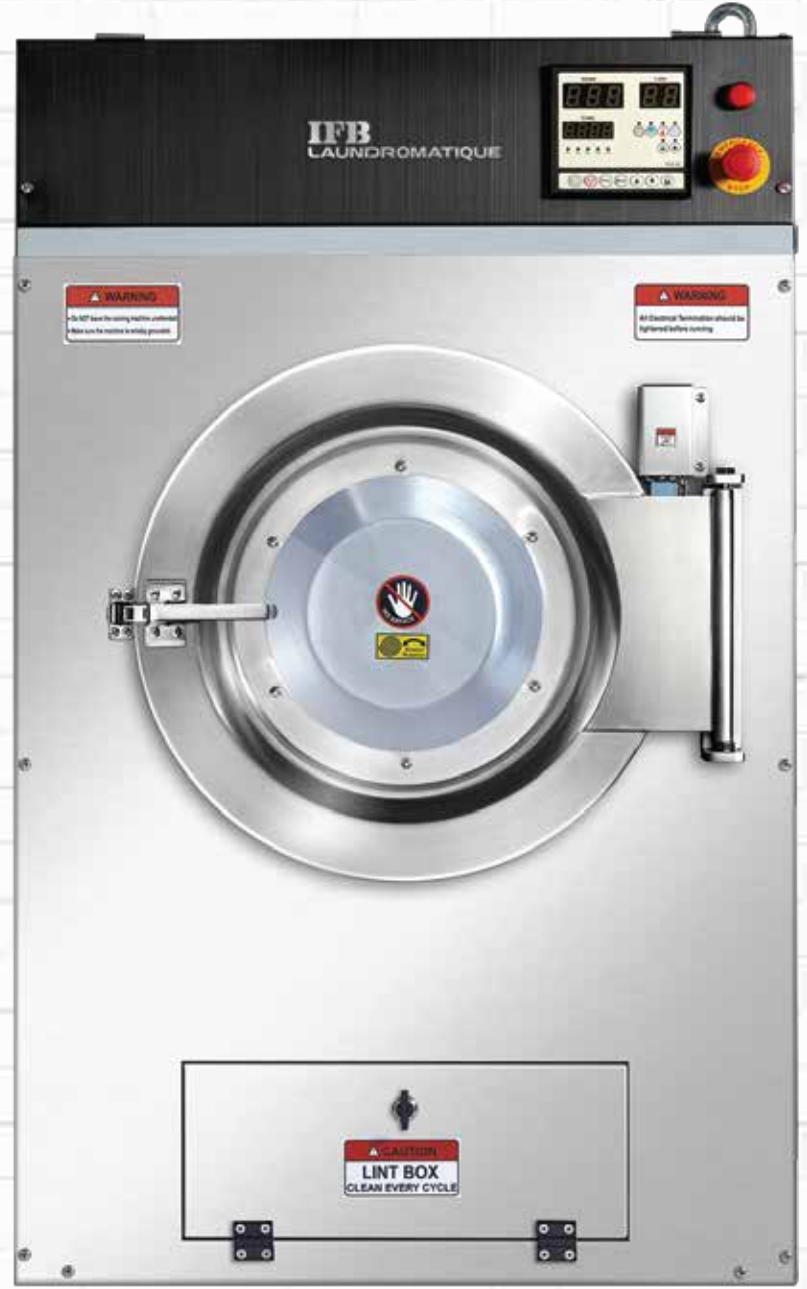

**STAINLESS STEEL OUTER BODY
CONSTRUCTION**



SS LINT FILTER



DOOR LIMIT SWITCH

TUMBLE DRYER (11KG) ITD 108

Capacity (kg)	11
Heating Type	Electrical
Motor Size (HP/kW)	1.5/1.1
Drive Motor (HP/kW/RPM)	0.5/0.37/925
Blower Motor (HP/kW/RPM)	0.5/0.37/1,240
Electrical Heating (kW)	9
Basket Speed (RPM)	35 ± 3
Basket Capacity	
Volume (Ltr)	212
Diameter (mm)	681
Depth (mm)	582
Dimensions	
Width (in/mm)	31/790
Depth (in/mm)	43/1,100
Height (in/mm)	49/1,250
Door Diameter (in/mm)	18/465
Crated Dimensions	
Width (in/mm)	34/860
Depth (in/mm)	48/1,210
Height (in/mm)	54/1,370
Approximate Weight	
Uncarted (lb/kg)	638/290
Carted (lb/kg)	691/314
Electrical Requirements	
Electrical Rating	415 V, 50 Hz, 3 Phase + N + E
Breaker/Fuse (Amp)	20
Operating Control	
PLC Model	TDC-01
Door Locking	Safety Limit Switch
Optional Features	
Remote Control through Mobile/Wi-Fi App	
Warranty	1 Year

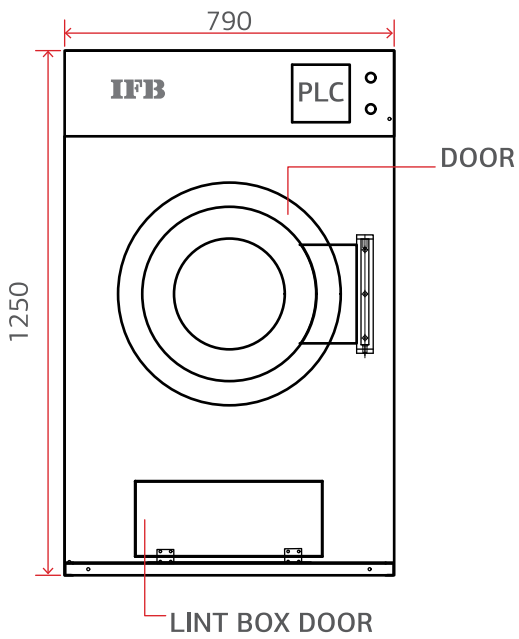

FRONT VIEW

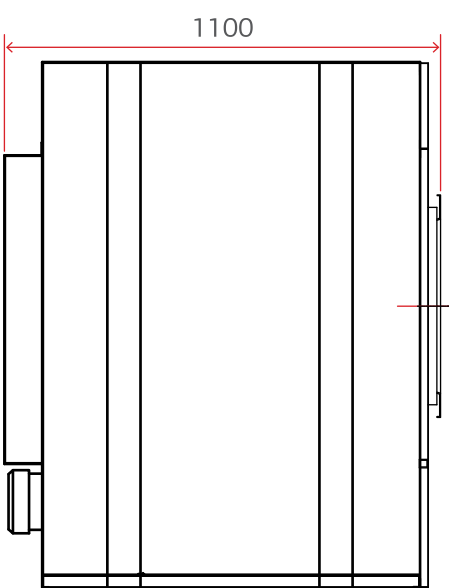

SIDE VIEW

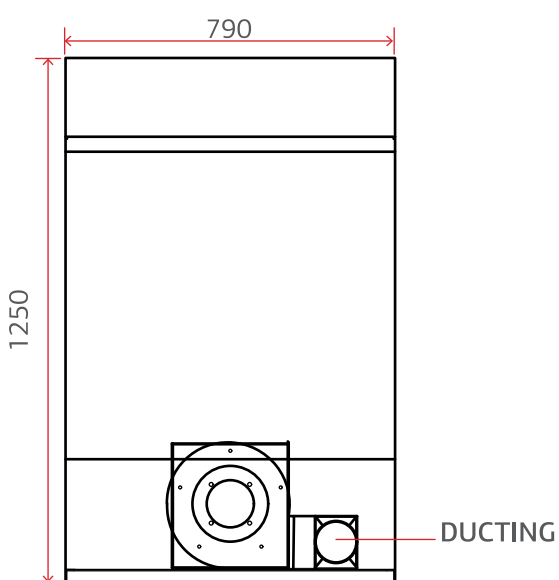

REAR VIEW

THE IFB ADVANTAGE



IFB has been offering commercial laundry equipment for sale throughout India for many years. As the foremost commercial laundry equipment supplier and service provider in the country, we're proud to sell and install the highest quality commercial laundry and laundromat equipment available in the market.

LAUNDROMATIQUE'S EDGE

11 Kg Smart Duo

Washes and dries in just 80 minutes!

Fully Stainless Steel Body

Bi-directional Rotation

Two Separate Machines; Easy Fit

Industrial Grade Weight Good Stability

Can be used for up to 10 hours a day



IFB *essentials*

We offer a 360° set-up with our range of laundry detergents and fabric care solutions. IFB has been the first choice of the several industries because of our strong focus and commitment. We have ensured sustained upgradation of technology and unbeatable performance with our continuous efforts.

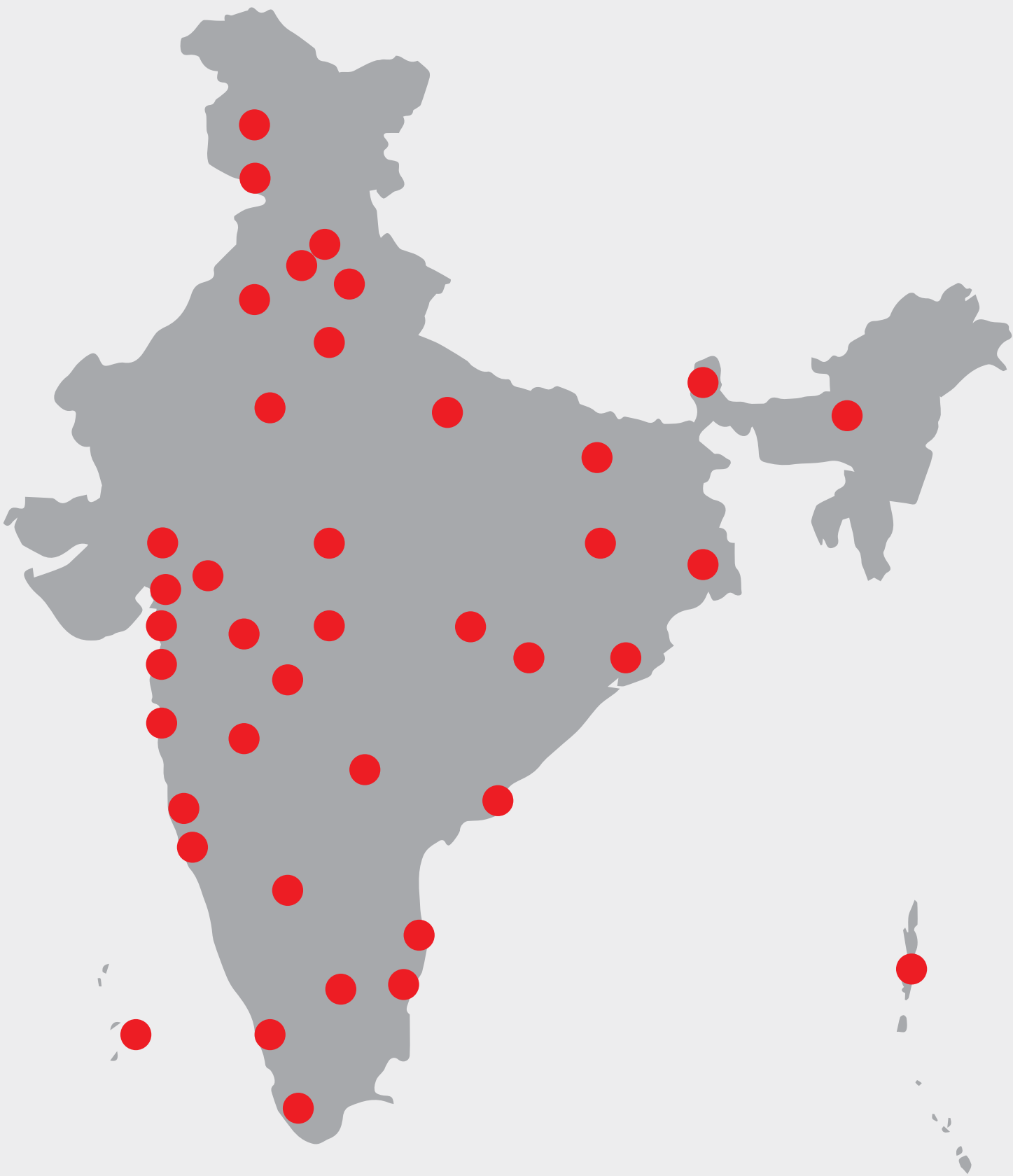

SERVICE TO THE NATION, SERVICE TO YOU

**At IFB, our customers are our
No 1 priority!**

We offer seamless service and support for minimal downtime. Our service experts across India are well equipped to handle any problem with the machine. Quick service is ensured as an inventory of spare parts is maintained across all the main branches in the country. Our machines are CE certified and come with a standard warranty of 1 year, supported with AMC for post warranty period.

IFB CARE

**CALL 1860 208 5678
OR 1860 425 5678**

IFB LAUNDROMATIQUE

Your partner in growing your business

COMMERCIAL LAUNDRY RANGE



Washer Extractor



Tumble Dryer



Dry Cleaner



Tufftec Dress O Matic

THEY TRUST US, SO WILL YOU!



For enquiries, kindly contact 1860 208 5678/1860 425 5678
or email us at customerservice@ifbglobal.com

www.ifbappliances.com